

STEINBERG

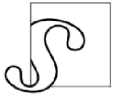

Waschtisch-Einhebelmischbatterie

Art.Nr. 180 1700

Installation

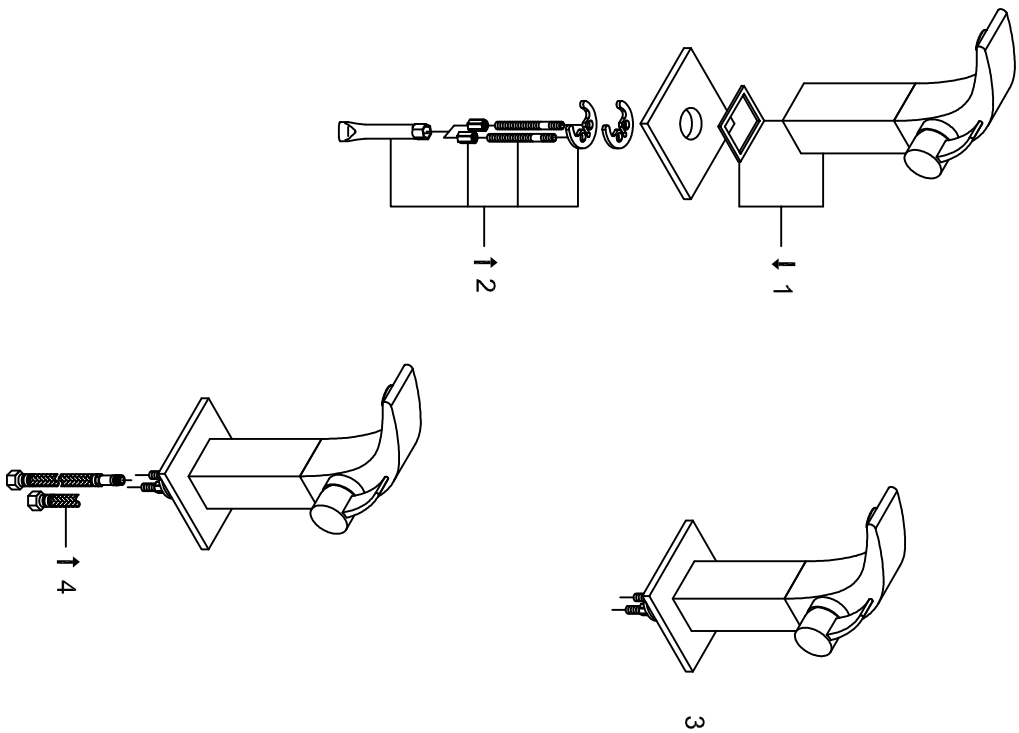

Technische Zeichnung

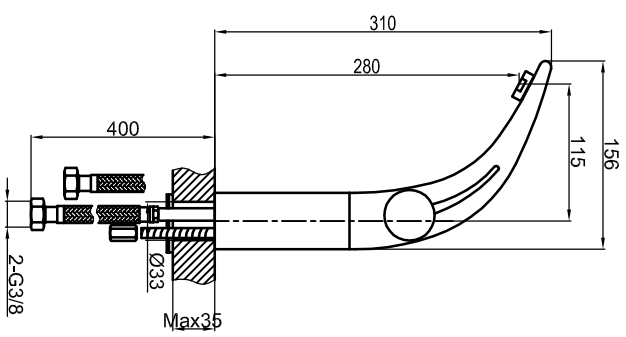

Explosionszeichnung

