

STEINBERG



Waschtisch-Einhebelmischbatterie

Art.Nr. 160 1500

Installation

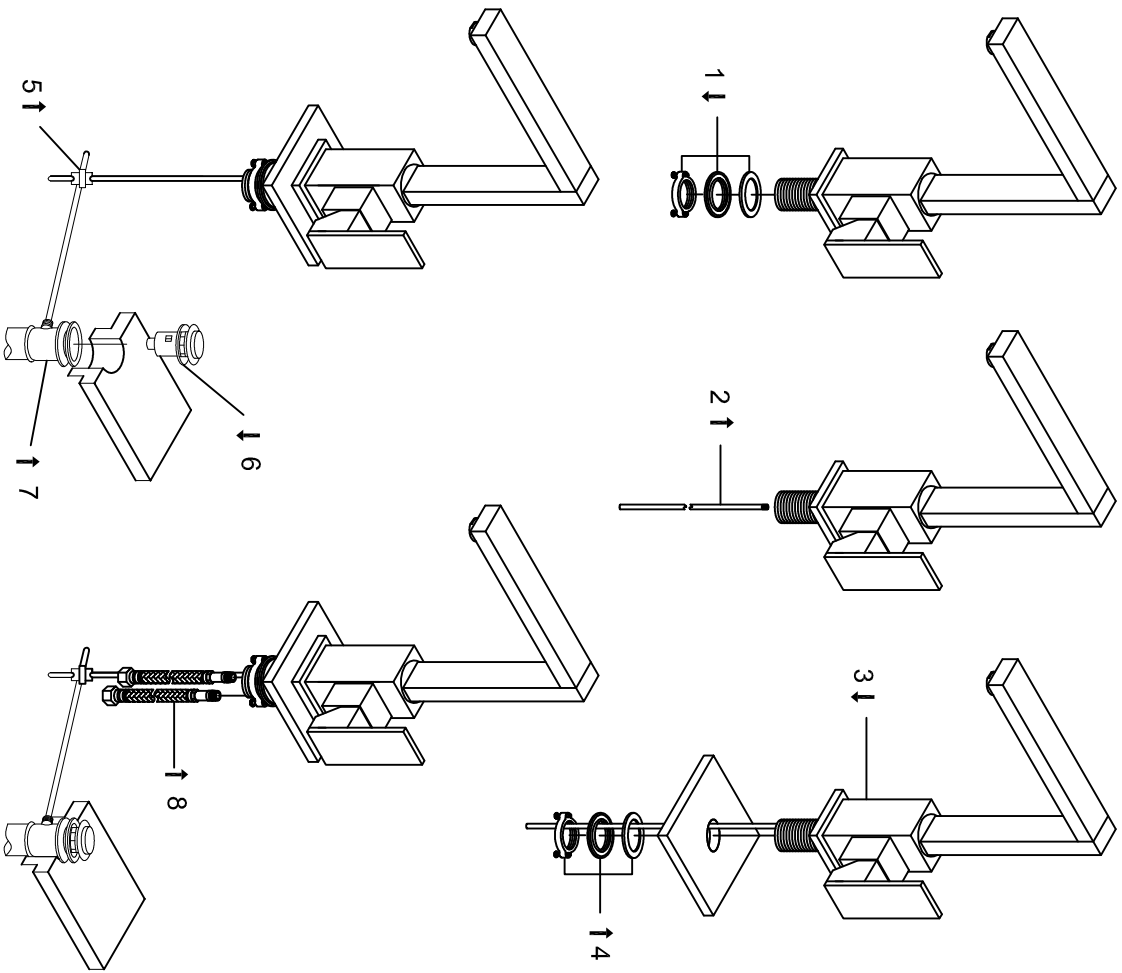

Technische Zeichnung

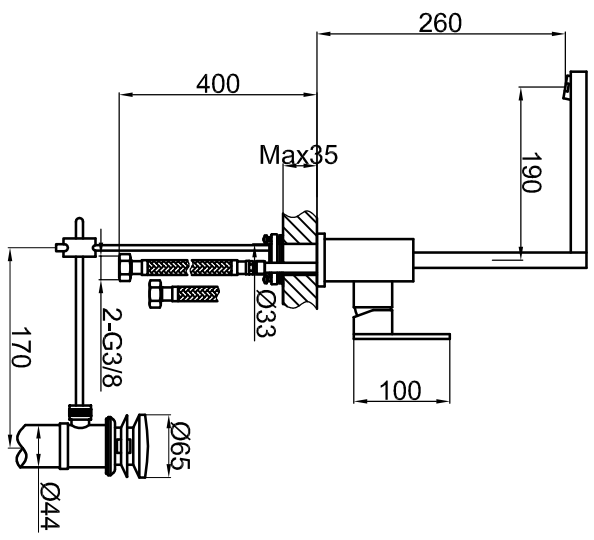

Explosionszeichnung

