



**TERMA**  
SINCE 1990

# Dexter Pro

RAL 3027 // 1220 — 500 // KTX 2

MODERN



DESIGN: Dariusz Berus, Daniel Dawidowski

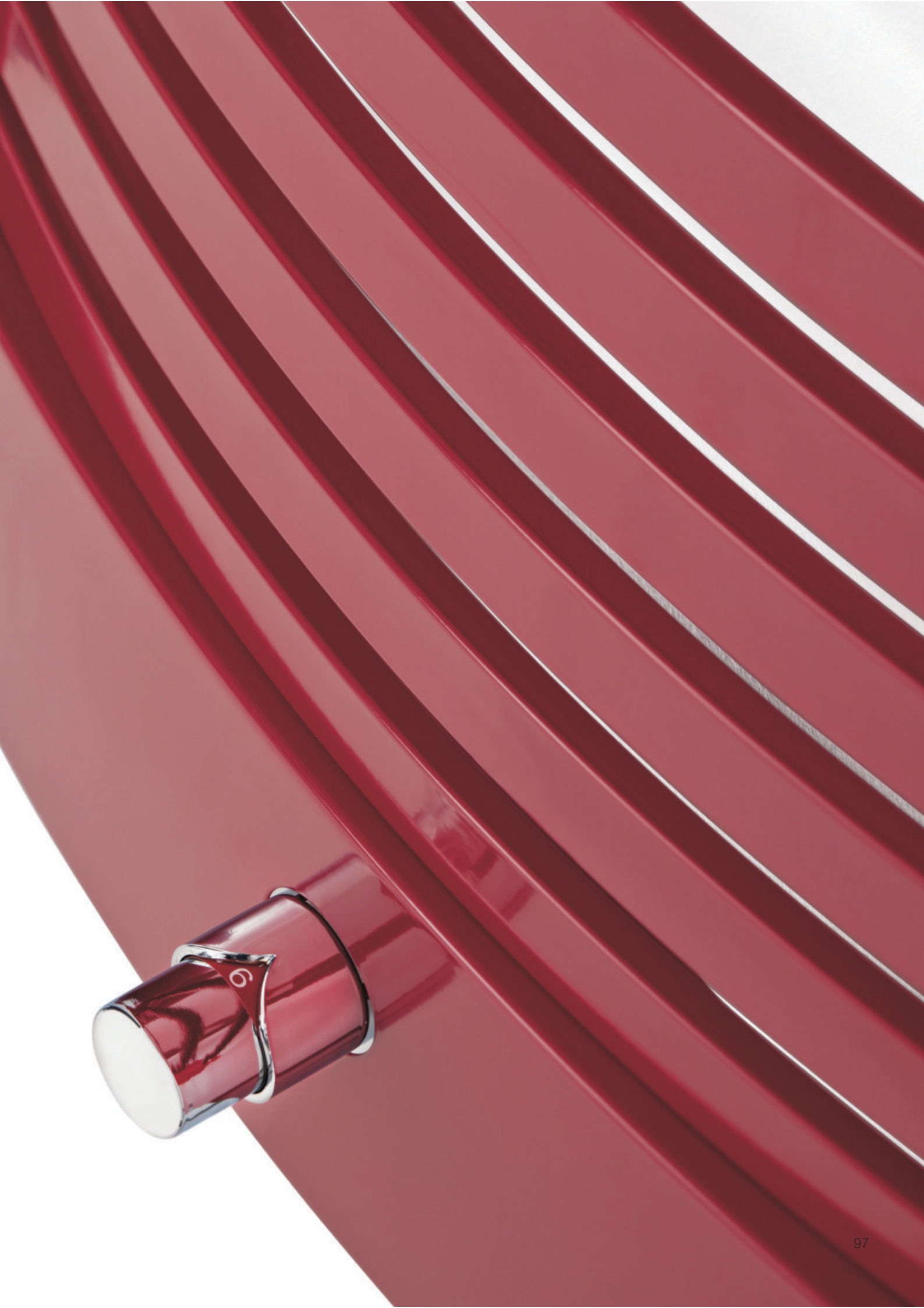



Standard connections:

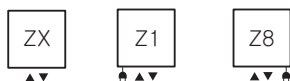

Sizes available:

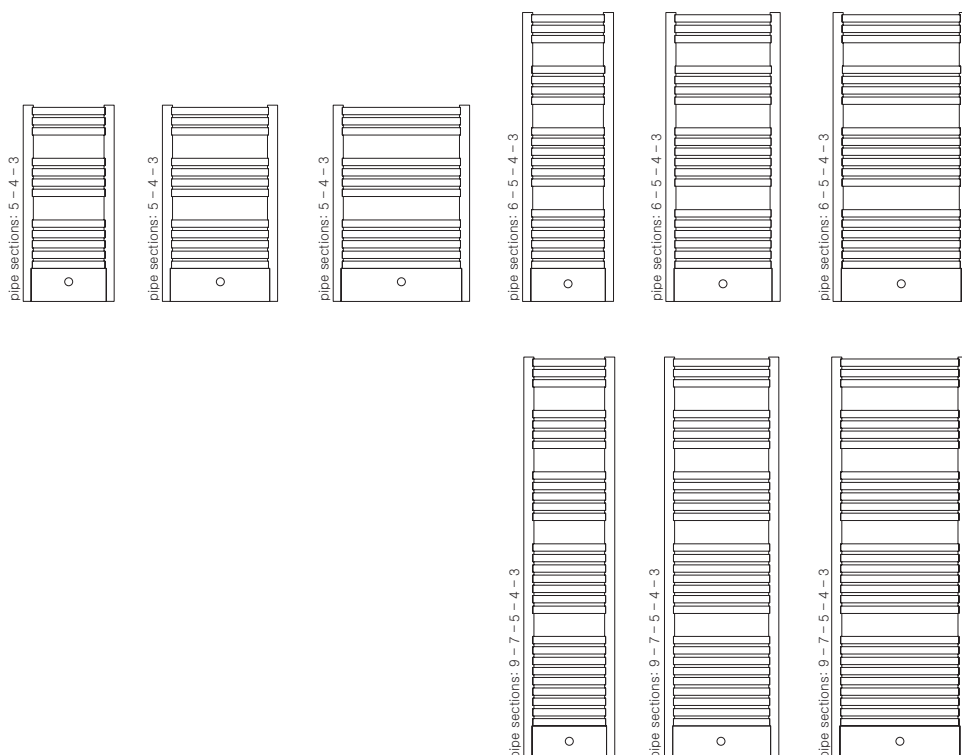

A	B	C	C'	75° 65° 20°	55° 45° 20°		D	E	F		
[mm]	[mm]	[mm]	[mm]	[W]	[W]	[W]	[mm]	[mm]	[mm]	[dm³]	[Kg]
860	400	50	—	326	173	300	350	680	90	2,6	7,2
860	500	50	—	408	216	400	450	680	90	2,8	8,3
860	600	50	—	488	259	600	550	680	90	3,1	9,4
1220	400	50	—	429	232	400	350	1040	90	3,7	10,0
1220	500	50	—	536	289	600	450	1040	90	4,0	11,6
1220	600	50	—	645	348	600	550	1040	90	4,4	13,2
1760	400	50	—	601	323	600	350	1580	90	5,4	14,5
1760	500	50	—	751	403	800	450	1580	90	6,0	17,0
1760	600	50	—	900	483	1000	550	1580	90	6,5	19,4

Radiator on offer with thermostatic head, valve block as well as thermostatic liner and two cut-off valves.

Im Heizkörperset inbegriffen: Thermostatkopf, Thermostatablock und zwei Absperrventile

Radiateur vendu ensemble avec tête thermostatique, bloc vannes, cartouche thermostatique et deux vannes d'arrêt.

Радиатор продается в комплекте с термостатической головкой, блоком вентилей с термостатическим картриджем, а также двумя отсекающими вентилями.

ZX

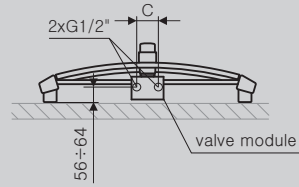

Z1

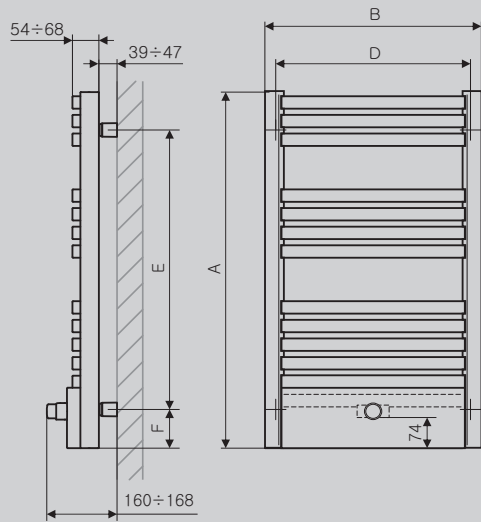
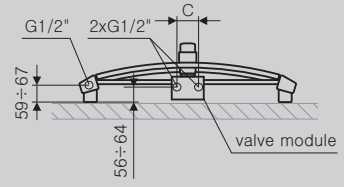

Z8

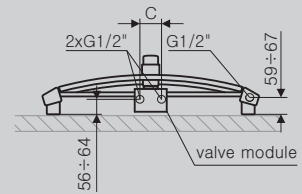

Radiator Collector

Profile

