



**TERMA**

SINCE 1990

# Dexter

MODERN

CHROME // 1220 — 500 // Dexter thermostatic (valve) set with male thread + “Slim” thermostatic head



DESIGN: Dariusz Berus, Daniel Dawidowski





Standard connections:

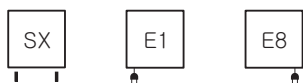

Available on demand:

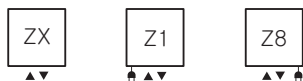

Sizes available:

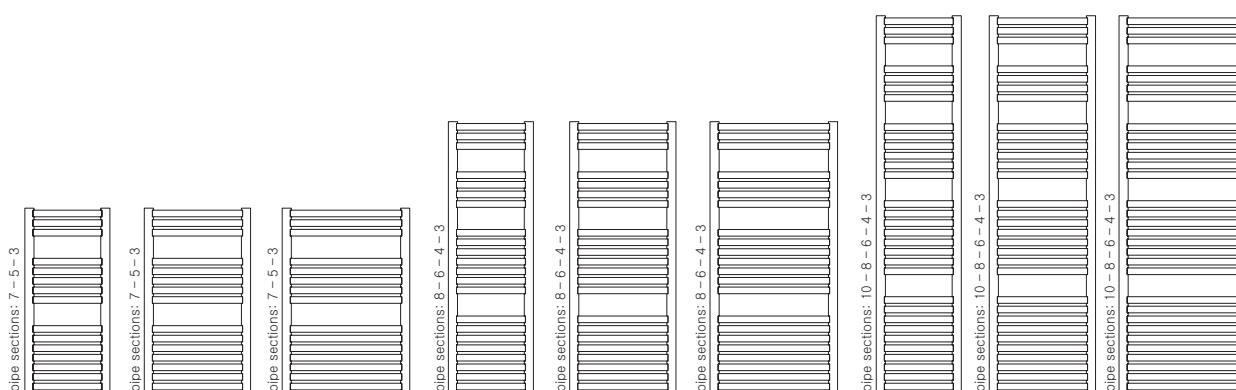

A	B	C	C'	$\frac{75^\circ}{65^\circ}$ $\frac{20^\circ}{20^\circ}$	$\frac{55^\circ}{45^\circ}$ $\frac{20^\circ}{20^\circ}$		D	E	F		
[mm]	[mm]	[mm]	[mm]	[W]	[W]	[W]	[mm]	[mm]	[mm]	[dm³]	[Kg]
860	400	357	50	338	178	400	350	680	90	2,7	7,1
860	500	457	50	422	222	400	450	680	90	3,0	8,4
860	600	557	50	510	269	600	550	680	90	3,3	9,6
1220	400	357	50	453	241	600	350	1040	90	3,8	9,9
1220	500	457	50	567	301	600	450	1040	90	4,2	11,7
1220	600	557	50	676	359	800	550	1040	90	4,6	13,5
1760	400	357	50	646	341	800	350	1580	90	5,6	14,4
1760	500	457	50	807	426	800	450	1580	90	6,1	17,1
1760	600	557	50	971	512	1000	550	1580	90	6,7	19,7

chrome version

860	400	357	50	225	117	300	350	680	90	2,7	7,1
860	500	457	50	281	147	300	450	680	90	3,0	8,4
860	600	557	50	337	172	300	550	680	90	3,3	9,6
1220	400	357	50	298	155	300	350	1040	90	3,8	9,9
1220	500	457	50	373	194	400	450	1040	90	4,2	11,7
1220	600	557	50	448	233	400	550	1040	90	4,6	13,5
1760	400	357	50	421	218	600	350	1580	90	5,6	14,4
1760	500	457	50	526	273	600	450	1580	90	6,1	17,1
1760	600	557	50	631	327	600	550	1580	90	6,7	19,7

SX

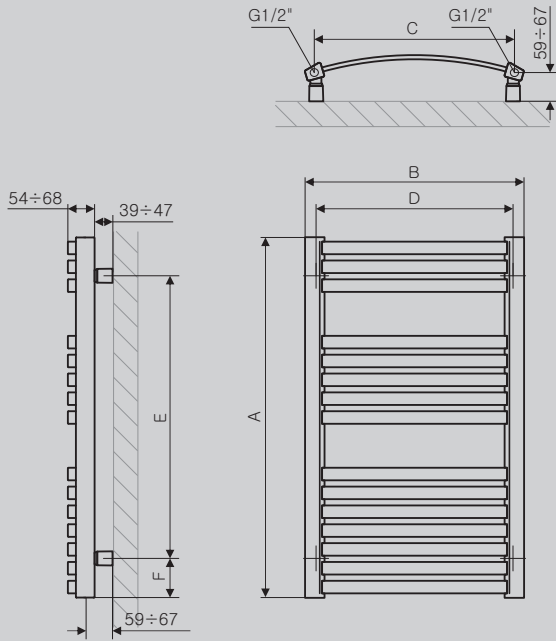

ZX

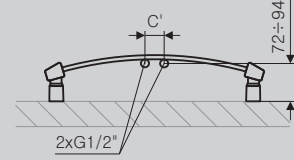

Z1

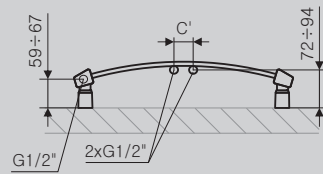

Z8

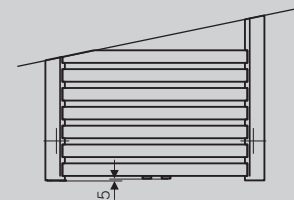
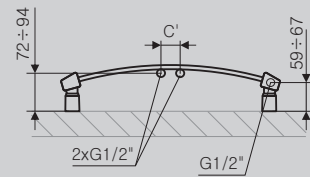

Radiator Collector

Profile

