



TERMA

SINCE 1990

Delfin

CALIFORNIA BEIGE // 1800 — 580 // 50 mm connection valve + “Slim” thermostatic head

LUX

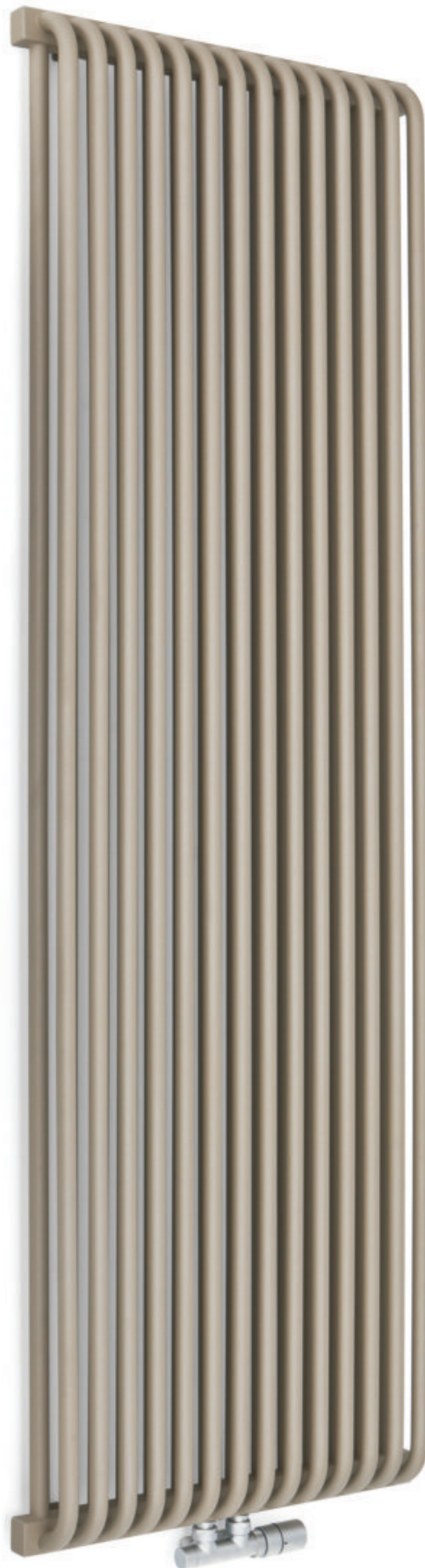



Radiator available in the following heights:
440, 540 and 640

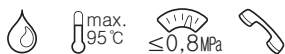

Standard connections:

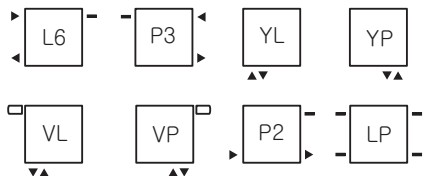

Sizes available:

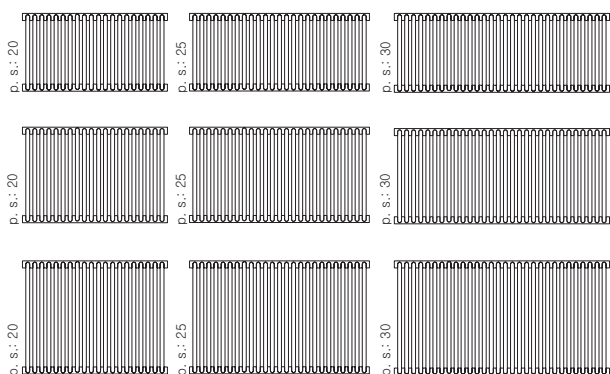

Radiator available in the following heights:
1800 and 2000

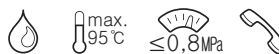

Standard connections:

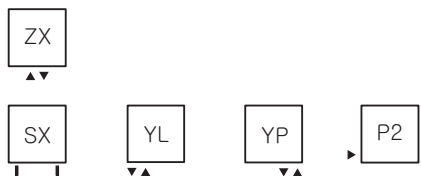

Sizes available:

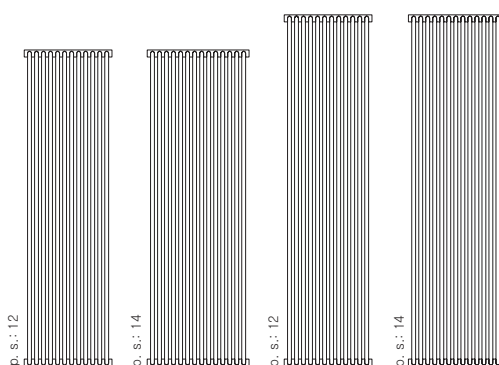

A	B	C	C'	C''	$\frac{75^\circ}{65^\circ}$ $\frac{20^\circ}{20^\circ}$	$\frac{55^\circ}{45^\circ}$ $\frac{20^\circ}{20^\circ}$		D	E	F		
[mm]	[mm]	[mm]	[mm]	[mm]	[W]	[W]	[W]	[mm]	[mm]	[mm]	[dm ³]	[Kg]
440	820	400	50	-	705	370	-	710	400	21	6,4	13,8
440	1020	400	50	-	885	465	-	710	400	21	8,0	17,1
440	1220	400	50	-	1061	556	-	710	400	21	12,8	27,3
540	820	500	50	-	846	442	-	910	500	21	7,6	16,3
540	1020	500	50	-	1057	552	-	910	500	21	9,5	20,4
540	1220	500	50	-	1264	661	-	910	500	21	11,4	24,4
640	820	600	50	-	986	514	-	1110	600	21	8,8	18,9
640	1020	600	50	-	1233	644	-	1110	600	21	11,0	23,6
640	1220	600	50	-	1458	760	-	1110	600	21	13,2	28,2
1800	500	50	460	500	1391	717	-	360	1760	21	12,9	34,2
1800	580	50	540	580	1623	830	-	440	1760	21	15,1	39,9
2000	500	50	460	500	1556	802	-	360	1960	21	14,3	37,9
2000	580	50	540	580	1774	909	-	440	1960	21	16,7	44,1

Radiator available in the following heights: 440, 540 and 640:

L6

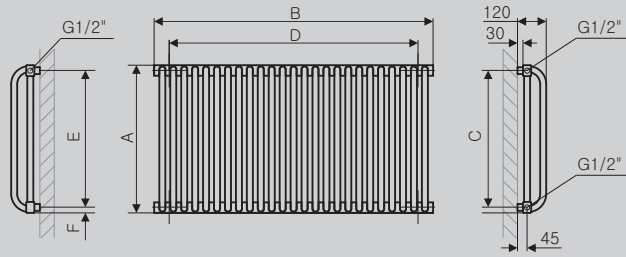

YL, VL

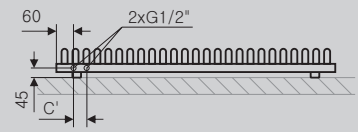

P3

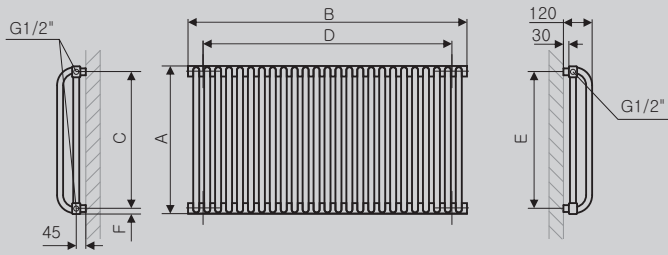

YP, VP

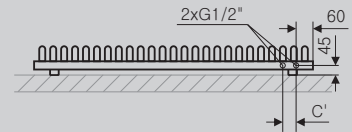

Radiator available in the following heights: 1800 and 2000:

P2

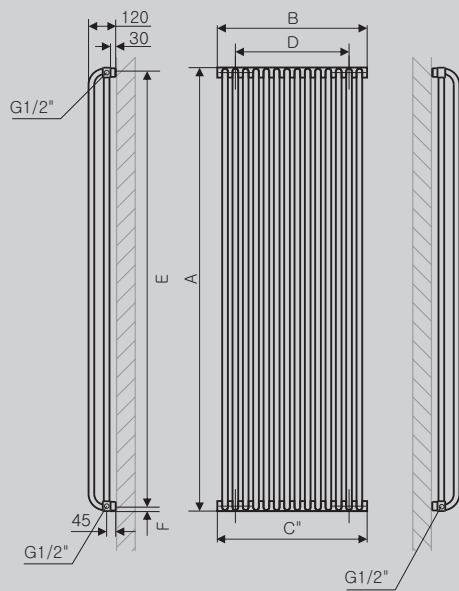

ZX

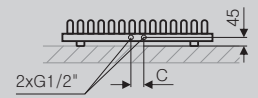

SX

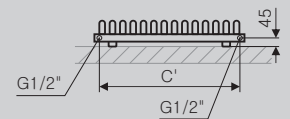

YL

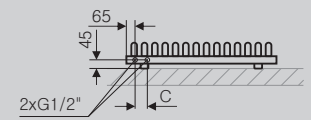

YP

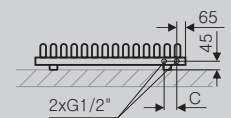

Radiator Collector

Profile

